

# P754PXEXT PEX STEM EXTENSION

## Specification Sheet

### FEATURES & BENEFITS

- 754 PEX Ball Valve Stem Extension
- Fits PEX & F1960 PEX Valves
- Height Increase 2.17 in.
- Sizes 1/2" - 1"

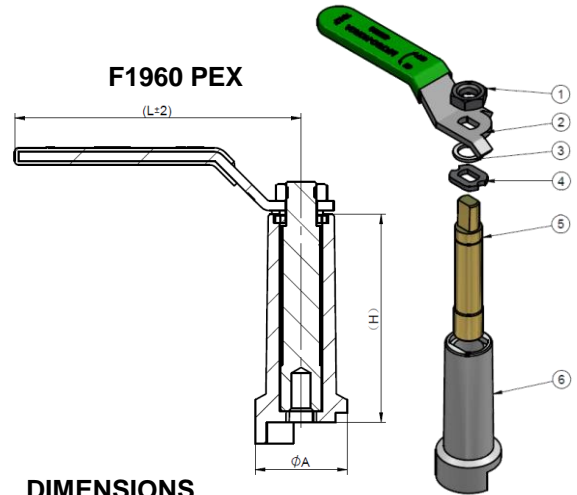
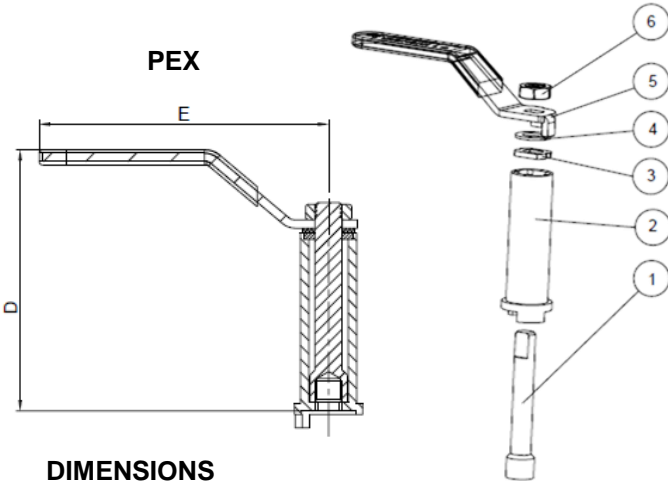

### DIMENSIONS

Part #	Size	D	E
P754PXEXT03LF	1/2"	3.01	3.35
P754PXEXT04LF	3/4"	3.01	3.35
P754PXEXT05LF	1"	2.95	4.02

### DIMENSIONS

Part #	Size	A	L	H
P754PXCEXT03LF	1/2"	0.95	2.96	2.13
P754PXCEXT04LF	3/4"	0.95	3.19	2.13
P754PXCEXT05LF	1"	1.02	4.18	2.17

### MATERIAL SPECIFICATIONS

No.	Part	Material
1	Rod	Brass
2	Sleeve	AL
3	Gasket	Steel
4	Washer	Plastic
5	Handle	Steel
6	Nut	Steel

### MATERIAL SPECIFICATIONS

No.	Part	Material
1	Hex-Nut	Steel
2	Handle	Steel
3	Washer	PTFE
4	Gasket	Steel
5	Heighten Stem	Local Brass
6	Heighten Stem Cover	Aluminum Alloy